



# Keor FLEX

THREE-PHASE  
Modular UPS up to 1.2 MW



#legrandImprovingLives



# SUSTAINABILITY

## CORPORATE SOCIAL RESPONSIBILITY

Green management and sustainable supply chain: these concepts are part of Legrand's Corporate Social Responsibility, which is the company's commitment to drawing up a strategy and implementing it with practical actions aimed at socially responsible behaviour towards everything around it, such as people, things and environment.

CSR involves the management of human resources, the organisation and division of labour and the management of natural resources. CSR aims to assess the impact that the company's actions and decisions have internally, but also externally, on the stakeholders and the environment.

### BUSINESS ECOSYSTEM

or how Legrand interacts ethically with the whole ecosystem of its activities.

### PEOPLE

or how Legrand engages with all of its employees and stakeholders.

### ENVIRONMENT

or how Legrand intends to limit the Group's environmental impact.

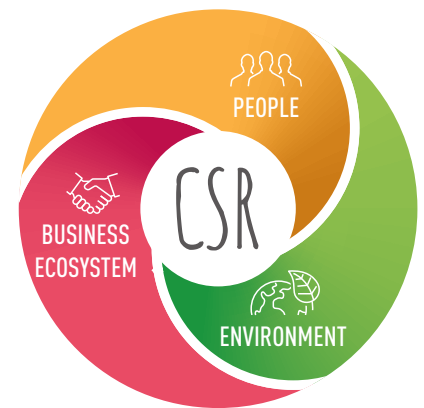

## CIRCULAR ECONOMY

We are committed to creating a system that involves all stakeholders to share values, objectives and actions in order to control and reduce the environmental impact of all our economic and production processes, reduce waste and environmental impact and transform what would once have been defined as «waste» into new resources.

Controlling these aspects has an impact on the entire life cycle of the product, starting from the design of new concepts and new specifications for the materials the UPS is made of; this is possible through responsible design and procurement processes (so-called «green procurement»), with a strong focus on research and the use of innovative materials from the circular economy and alternative raw materials. When a product ends its life, all these materials can become high value-added resources that can be used in other production cycles.



## DIGITALISATION

Many of our documents are now available in a digital format to view on a PC or smartphone, not only making them always accessible but also reducing the amount of paper we use.

Digitalisation also becomes an important driver of the circular economy, since it allows the use of tools for performance data analysis and preventive diagnostics, both useful for optimising the life cycle and durability of the product.

## EFFICIENCY

Our R&D team is constantly working on the development of increasingly efficient UPSs that allow high and incremental performance with minimum energy dissipation; with regard to CO<sub>2</sub> emissions, we are implementing processes and products that represent an improvement in the percentage of carbon footprint compared to the past.

But efficiency is not only synonymous with high performance.

For us, efficiency also means ecodesign: this implies that the UPS is designed to be easily repaired, maintained and it's easy to separate its components.

This means increasing the durability of our UPSs and the possibility of reusing and recycling them at the end of their life.



## EPD/PEP

For each product family we draw up an EPD (Environmental Product Declaration) or PEP (Profil Environnemental Produit) in line with ISO 14025: it is a declaration that is a sort of environmental photograph of the product.

The EPD is drawn up according to the concept of Life Cycle Assessment: it examines the environmental impact of a product throughout its life cycle, from the development of product specifications to the choice of materials to be used and the end-of-life destination of the product itself.

UPservice contains the full documentation of UPS products in digital format. This tool allows to reduce the use of paper documents in favour of the digital format for the benefit of a lower environmental impact. Visit our website **ups.legrand.com** to download the app.





# COMPLETE INTEGR

With ever-increasing demands for data storage and processing, generated by Artificial Intelligence applications, Big Data, Cloud computing and the Internet of Things, IT infrastructure have definitely become the core center of companies and their economic expansion. Trust Legrand to empower your Data Center infrastructure: its High know-how, innovative product offering, specialist brands and expert teams, make the Group the right partner to choose.

Legrand group offers a wide range of solutions for distribution, protection, control and management of plants and electrical installations for all types of applications, from industrial and commercial sectors to infrastructures.



# ATED SOLUTION

## INFRASTRUCTURES POWERED BY EXPERTS

Our award-winning solutions, recognized by leading Data Center providers, ensure optimal performance for mission-critical operations. A team of specialists designs tailor-made solutions, combining innovation and reliability to meet the most demanding needs.

We provide consistent, high-quality support through the expertise of our local and central teams, always ready to deliver the best services and support.



UPS  
system

Electric  
distribution



# Keor FLEX

## Power and flexibility without compromise

**Keor FLEX** is a modular UPS system that setting the stage for a new era in high-efficiency power solutions, providing maximum protection. With a capacity reaching up to 1.2 MW and a compact design, **Keor FLEX** is engineered for effortless installation and maintenance, ensuring uninterrupted power availability and minimises Total Cost of Ownership (TCO).

### Choose **Keor FLEX**

- **Proven Technology:** Built on a heritage of over 50 years of UPS experience.
- **Efficiency Redefined:** 98.4% Tailored for expansive Data Centers, **Keor FLEX** redefines performance standards.
- **Resilience:** Engineered for seamless installation and maintenance, guaranteeing uninterrupted power
- **Flexibility:** Based on a modular design principle, this UPS can achieve 1.2 MW through deployment of up to 12 x 100KW Hot Swappable/Scalable Power Modules

#### EFFICIENT

98.4%

Power module double conversion efficiency



#### COMPACT

1.2MW

in only 2.8m<sup>2</sup>



#### SCALABLE

Pay-as-you-grow thanks to Modular Conception and Parallelability up to 4.8 MW



Higher UPTIME  
Optimized TCO

#### RESILIENT

Robust and Innovative internal busbar design



#### AVAILABLE

True hot-swap modularity with hot synchronization



#### SMART

Smart Grid Compatibility. Predictive Diagnostic

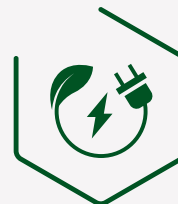





**Keor FLEX**, our latest three-phase modular UPS system, designed to provide maximum protection and reliability for your IT environments and Data Centers.



# Keor FLEX

## Innovative performance elements



### EFFICIENCY Maximize your power

Thanks to silicon carbide (SiC) technology, the system can achieve the highest levels of efficiency at all load levels.  
Exceeding up to **98.4%** in online mode.

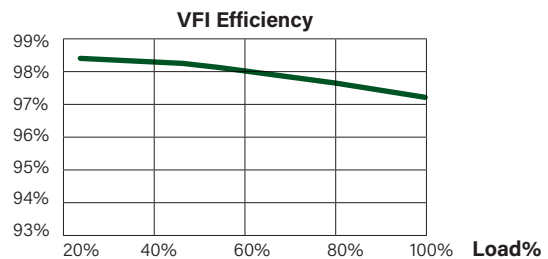

### FLEXIBILITY Limitless power possibilities

Based on a modular design principle, the **Keor FLEX** UPS can achieve 1.2 MW through deployment of up to 12 x 100 KW Hot Swappable/Scalable Power Modules.  
For rating exceeding 1200KW, the **Keor FLEX** UPS can reach a maximum power rating of 4.8 MW by configuring up to 4 systems in parallel.

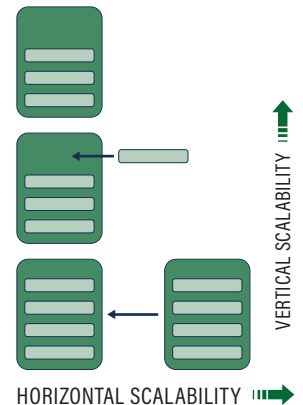





## ADAPTABILITY

### Tailored adaptability for your unique needs

The System can be easily adapted to the surrounding electrical system allowing:

- Bottom or Top Entry cable or Busbar Connection
- TNC or TNS Grounding
- With or Without Distributed Neutral (3Ph+N or just 3Ph)
- Integration with upstream panel Protections and Switches
- Icw limitation system
- Embedded Backfeed protection
- Trapped Key Error-proof for Operations on Switches and Manual Bypass



## ELECTRIC ROBUSTNESS

### Secured power resilience

High fault clearance capability: Inverter 3xIn and By-pass 20xIn  
Robust Internal Busbars, Plugs, and Power Electronics ensure electromechanical resiliency in case of intense short circuits.

LI-ION

## LI-ION COMPATIBILITY

### High-rated performance batteries

Backup energy in compact footprint, long operating time and complete supervision of the system. Compatible with high-performance Li-Ion batteries using LFP and NCM technology



## SIMPLICITY AND RELIABILITY

### Simplified operations, unmatched reliability

Innovative internal busbar design featuring smart bar connectors, ensuring a robust modular system with minimal modules.  
This innovative design delivers simplicity and reliability in power distribution.

PATENT PENDING

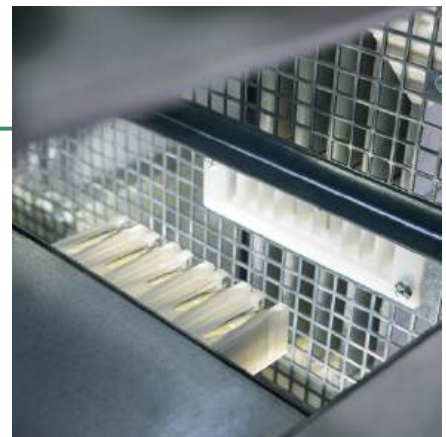

# Keor FLEX

## Innovative design



### ECO FRIENDLY DESIGN

#### Attention for the environment

Legrand's ambition has been to reduce the environmental footprint with **Keor FLEX**, by giving priority to the circular economy, reducing the quantity of materials used, promoting the reuse of materials and improving the system efficiency.



### 10" HMI TOUCH SCREEN

#### Effortless control at your fingertips

**Keor FLEX** provides an easy and intuitive interface, enabling comprehensive measurements and parameters from the entire system down to individual modules. The display streamlines detailed historical logs of alarms and messages, complemented by the latest predictive diagnostics. The screen also allows users to manage and configure the system following specific load and application requirements.





## COMPACTNESS

Because space matters

Each component of the system is precisely designed to ensure maximum reliability and performance while emphasizing ease of installation and maintenance. The compact design offers up to 1200 kW within 2.8 m<sup>2</sup>, with top front ventilation, flexible cable (top or bottom) or via busbar connection, including distribution switches without the need for extra cabinets.



## WIDE & INNOVATIVE STATUS LIGHT

Effortless monitoring, enhanced visibility

A distinctive feature of **Keor FLEX** UPS, a multi-colored LED status bar employs traffic-light codes for an immediate and clear display of the operational status.

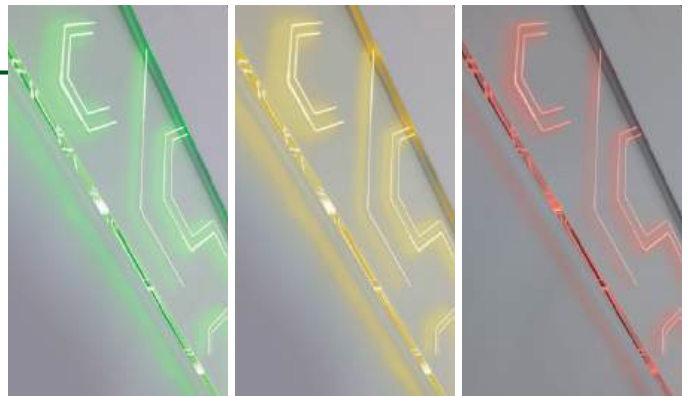



# Keor FLEX

## Maintainability Management & Serviceability



### TCO OPTIMIZATION Unlock savings

Predictive diagnostics, user-friendly design, and simplified maintenance contribute to substantial reductions in operating and management costs.

### IN 8 YEARS OF OPERATING LIFE

- 27% Energy Consumption
- 31% Carbon FootPrint
- 2.5 Years Return of Investment

(Compared to cutting-edge UPS on the market with 97% efficiency.)



### SMART ENERGY MANAGEMENT Sustainable power choices

#### Use your UPS System asset as a Distributed Energy Resource

- Import-export power from/to the grid
- Limit peak power absorbed from the grid (peak shaving)
- Grid frequency fast stabilizing
- Integration with Building Management Systems

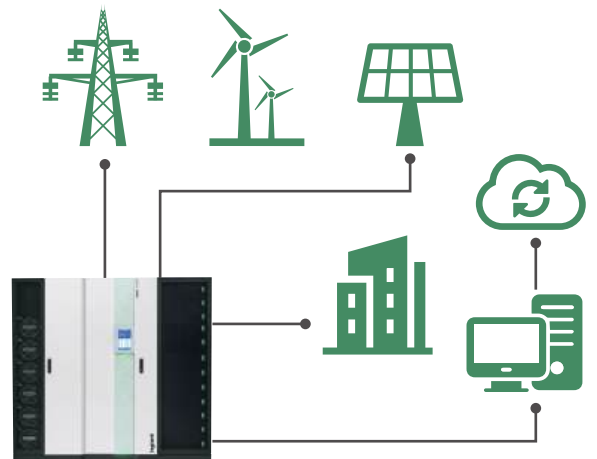



## COMPLETE ON-BOARD COMMUNICATION

### Comprehensive connectivity

#### FRONT COMMUNICATION MODULE

The communication module is positioned on the front, is easily accessible and boasts a wide selection of communication interfaces.



## HOT SWAP MODULARITY

### Zero downtime

Independent, autonomous, and self-configuring Power Modules create a genuinely hot-swappable system allowing zero downtime in service operation. The modularity is extended also to the Static Bypass which is composed of 6 compact hot-swap modules. The result is "No Single Point of Failure (SPOF)".



BYPASS MODULE

POWER MODULE



## TOTAL FRONT ACCESS

### Maximum space saving

All operational and service tasks can be easily performed from the front, eliminating the need for rear access. This unique design allows the installation of the cabinet against the wall and facilitates service and ventilation. With **Keor FLEX** UPS, experience a space-saving solution that prioritizes ease of use and efficient use of space.



## PREDICTIVE DIAGNOSTIC

### Maximize uptime

The system incorporates an internal monitoring system and data processing capabilities. This facilitates real-time assessment of consumable component conditions, allowing for an optimized maintenance plan based on their actual expected life, minimizing unnecessary part replacements and maximizing equipment uptime with precision strategies.



## REDUCED MTTR

### Highest availability

The focus on a maintainable design ensures fast, secure operations, delivering a low Mean Time to Repair (MTTR) and high system availability. With **Keor FLEX** UPS's hot-swap modular design, critical power components can quickly be replaced, achieving an impressive MTTR of less than 5 minutes without interrupting UPS operation.

# Keor FLEX

## UPS Modular three-phase double conversion VFI



### General features:

- UPS system capacity up to 1200 kW
- Modular redundancy architecture (power modules and bypass modules)
- 10" touch screen display
- Double conversion efficiency up to 98.4%
- Efficiency in ECO mode up to 99%
- Output power factor = 1
- Controlled noise level
- Multi-colored LED status bar
- Parallelable system up to 4 units
- Hot-swappable modules
- Intelligence distributed between modules
- Smart-grid ready
- Total front access

Item	UPS Components		Dimensions (W x H x D mm)	Weight (kg)
9 000 91	UPS Cabinet (max 12 modules)	1200	2250 x 2100 x 1260	1335
3 113 90	Power Module	100	3U	60

### Configuration options

- 940103 With Distribution Switches
- 940104 Without Distribution Switches
- 940105 Icw limitation up to 100kA
- 940106 Internal BackFeed
- 940107 TNS
- 940108 TNC
- 940109 Cable top connection
- 940110 Cable bottom connection
- 940111 Busbar (top connection)
- 940112 Common input Rectifier + Bypass
- 940113 Dual Input Rectifier + Bypass
- 940122 Trapped key interlock Manual Bypass
- 940116 IP21 kit

### Characteristics

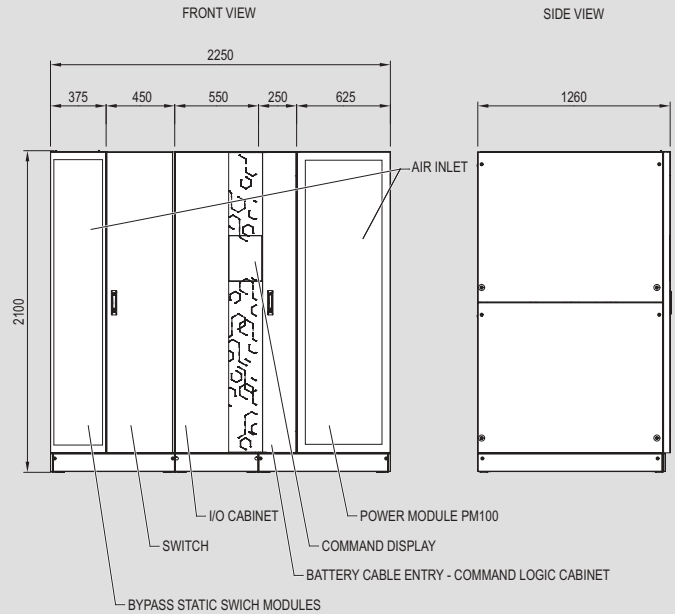
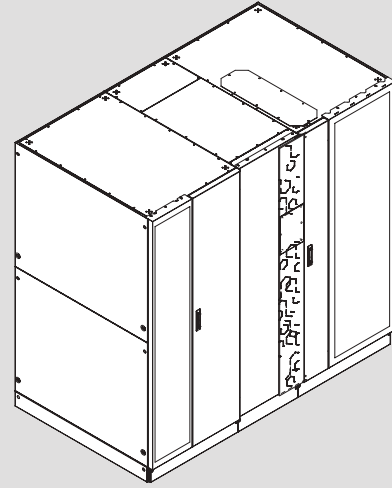



# Keor FLEX

## UPS Modular three-phase double conversion VFI

### Characteristics

General Characteristics	
Nominal power (kVA)	1200
Active power (kW)	1200
Classification	On-Line double conversion VFI-SS-111
Module power (kW)	100
No. Power modules	Up to 12
System	Modular, expandable and redundant UPS system
Input specifications	
Input voltage (V)	400
Input frequency (Hz)	50-60 Hz +/- 5Hz
Input voltage range (%)	+/-20
THD input current	< 3% ( at full load)
Compatibility with Genset	Yes
Input power factor	0.99
Output Specifications	
Output voltage	3-phase + N / 4-wire
Efficiency (power module)	98,5%
System efficiency	98,4%
Efficiency in Eco mode	99%
Nominal output frequency (Hz)	50/60 Hz
Crest factor	Up to 3
Waveform	Sinusoidal
Output voltage tolerance	±1%
THD output voltage	<1% with linear load, <3% with non-linear load
Overload capacity	125% 10 min; 150% 1 min (inverter)
Bypass	Automatic bypass (static and electromechanical) and manual maintenance bypass
Batteries	
Battery module	VRLA - Li-Ion - TPPL
Battery voltage range (Vdc)	420-680
Battery charger	20kW per Power Modules
Communication and management	
Display	10" touch screen display
Communication ports	2x Parallel ports, External Synchronization 2x Slot SNMP Adapter - Net Card, 1x TCP/IP Port Ethernet Mod-BUS, 1x RS485 Device interface (BMS), 1x CAN Device interface (BMS), Battery Protection Trip, Battery Room Temperature Sensor, Battery Room Alarm, 6x outputs digital contacts, 6x outputs analogic contacts, External Backfeed, Distribution Switches status.
Back feed protection	Internal Contactor and signal for external protection
Emergency Power Off (EPO)	Yes
Cold start push-button	Yes
Mechanical characteristics	
Height (mm)	2100
Width (mm)	2250
Depth (mm)	1260
Net weight (kg)	2100 (all modules installed)
Ambient Conditions	
Operating temperature/humidity	0-40/ <95% not condensing
Protection rating	IP20
Maximum audible noise at 1 m from the unit (dBA)	<75@50% load
Conformity	
Certifications	EN 62040-1, EN 62040-2, EN 62040-3

Legrand reserves the right to modify the data without notice

# CUSTOMER SERVICES



## Reliable

Directly present in more than 70 countries and servicing its products in more than 150 countries worldwide, a team of qualified engineers is available to support your UPS system to ensure power quality and availability to the most critical loads.

## Excellent

Legrand's competitive edge lies in its ability to provide high value-added UPS systems and services for both end users and business partners.

For Legrand, creating value means coming up with solutions for lower energy consumption, but also integrating product design into the overall development process. With around 200 000 catalogue items, the Group also provides all products required for electrical and digital building installations, particularly as integrated systems, finding solutions to fit everyone's needs.

## Tailor-made

Legrand offers a complete range of specific solutions and services to meet customer requirements:

- Technical pre-sales support at the project design stage
- Factory acceptance test
- Supervision of installation, testing and commissioning, site acceptance test
- Operator training
- Site audit
- Warranty extension
- Annual maintenance contract
- Fast intervention on emergency call

## SUPPORT



### **SITE INSPECTION, INSTALLATION SUPERVISION.**

We perform a comprehensive check of the UPS environment to ensure safety and fault-free operation. Our technical experts give manufacturer's recommendations to the site engineer or electrical contractors, and supervise the UPS installation before load power-up.

### **SITE TEST, FACTORY TEST, COMMISSIONING**

Our Service Engineers conduct rigorous site tests and full setting-up of the UPS system before going live. They also perform Site Acceptance Test (SAT) and Factory Acceptance Test (FAT) according to your requirements. Commissioning operations for all UPS are carried out by qualified engineers to guarantee seamless start-up. After the final handing over of the UPS system, a Test and Commissioning report is delivered to you.

## TRAINING



We offer on-site training to ensure your equipment's safe and efficient operation.

Troubleshooting courses are also available in our plants for intensive hands-on practice on UPS training equipment.

## MAINTENANCE



### **PREVENTIVE MAINTENANCE**

Electronic equipment and power systems, such as UPS, contain life-limited components and parts that must be replaced according to the manufacturer's specifications. To ensure optimal performance and to protect your critical application from potential downtime, it is crucial to perform

preventive maintenance operations on a regular basis and replace parts when needed. Our Service Contracts include cleaning, IR thermography, measurements, functional tests, event log and power quality analysis, battery health check, hardware and software upgrades, and technical reports.

A Preventive Maintenance Plan is one of the most cost-effective actions that can preserve your initial investment and ensure your business continuity.

### **CORRECTIVE MAINTENANCE, EMERGENCY CALL**

In the event of an Emergency Call, our worldwide service network, with engineers and spare-parts stocks strategically located as close as possible to your site, guarantees a fast intervention time with 24/7/365 assistance.

After connecting his laptop to your UPS, very powerful diagnostic software helps our engineer to identify the fault, thus ensuring short MTTR (Mean Time To Repair).

Corrective actions are performed such as part replacement, adjustments and upgrades to return the UPS system back to normal operation.



To learn more visit :

**[www.legrand.com/datacenter](http://www.legrand.com/datacenter)**

 **Legrand Data Center Solutions**

©2025 Legrand.